

BIANCO NXT

solar

NXT-FLEXI SOLAR

NXT FlexiSolar22	PN 811612
NXT FlexiSolar40	PN 811613
NXT FlexiSolar75	PN 811614

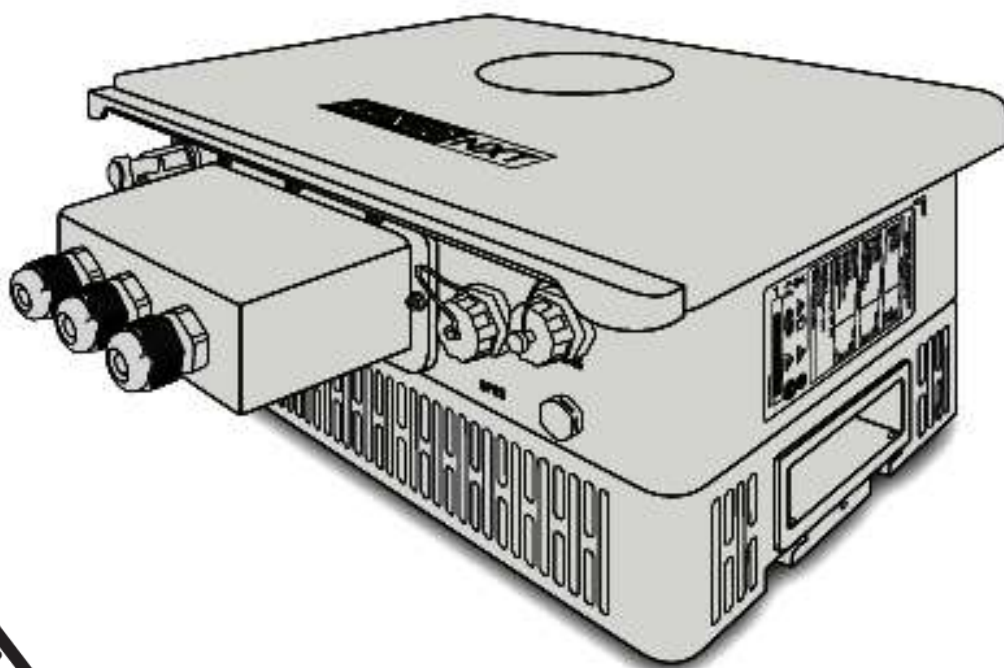

1. Introduction

Congratulations on the purchase of your **NXT FLEXI-SOLAR** hybrid solar pump controller.

The **NXT FLEXI-SOLAR** pump controller is a variable speed drive designed for three-phase asynchronous motors and permanent magnet synchronous motors. The controller provides motor soft-start, speed control, fault detection and motor protection.

The incoming power source can be DC, AC or a combination of both.

High-voltage DC power from a solar array is converted into AC power to drive the pump. When the solar energy drops, the controller can automatically switch to a backup AC power source, such as generator or battery storage

In situations of poor power supply (low solar irradiation or 'brown' power) the controller adjusts to maintain the output voltage and decreases the pump speed to match the available energy, protecting the system components from harm.

Typically, the **NXT FLEXI-SOLAR** pump controller will run when there is a demand for water and sufficient energy is available. When a water demand is detected, the controller slowly increases the motor speed while gradually increasing the motor voltage. The motor temperature and starting current of the solar water pump system are lower than DOL starting, extending the life expectancy of the motor.

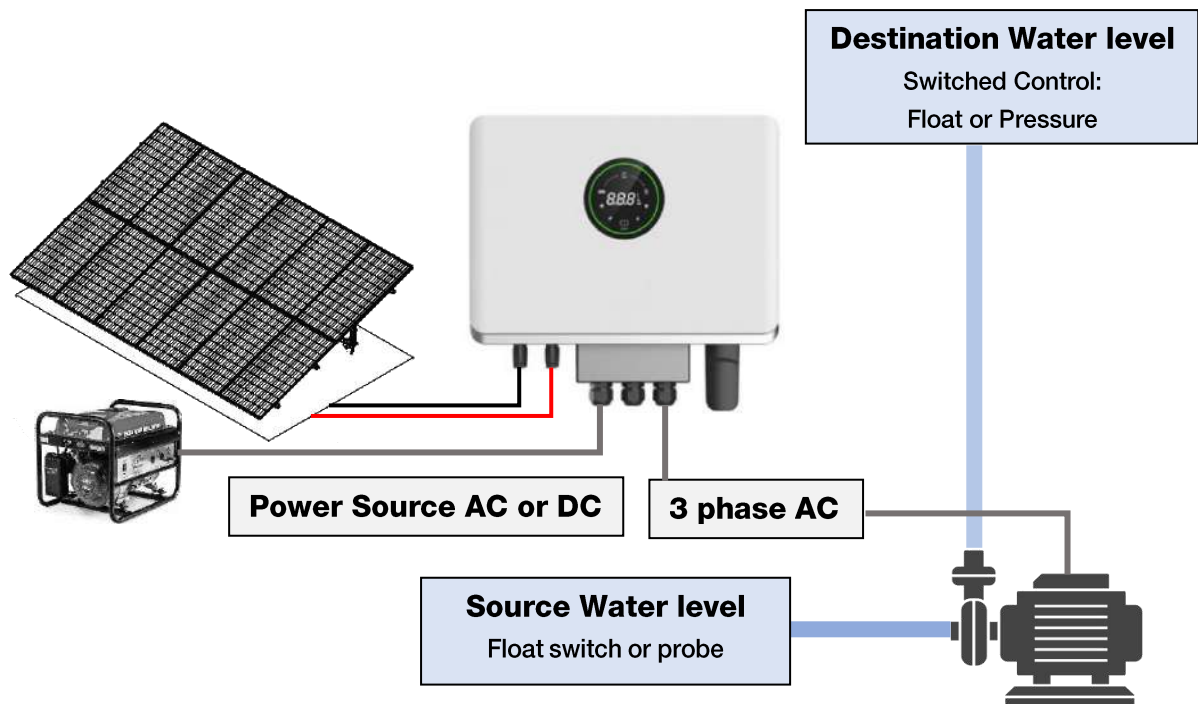

Performance of the system is continuously monitored to detect abnormal conditions. In many cases, the controller will provide compensation as needed to maintain uninterrupted running of the system.

If there is a possibility of equipment damage, **NXT FLEXI-SOLAR** will protect the system and display the fault status. Pumping will automatically resume after the fault cause is eliminated.

2. Key Features and Protections

Features:

- Optimised pump performance - Solar Maximum Power Point Tracking (MPPT)
- Soft start, low motor start current.
- Multi-pump control. 1 master and up to 5 auxiliary controllers

In-built Pump Protections:

The controller monitors the system and automatically shuts down when:

- The source water level is low
- The destination is full and further water is not required
- The pump is blocked or overloading.
- High voltage surge
- Low voltage input
- Motor phase loss
- Short circuit
- Controller internal over-temp

NOTE: This controller provides overload protection for the motor by preventing motor current from exceeding rated current and limited load operation at low water levels.

The controller does not provide motor overheat detection.

Controller Overheating Monitoring

The controller is designed to run at full power up to ambient temperatures of 45°C. At temperatures above 45°C, the controller reduces the carrier frequency (switching frequency of IGBT) to maintain operation as much as possible.







Water level control

Two optional water level detection devices (switch or probe) can be connected to provide additional control of the pump. Installed at the source, this prevents the pump running without water present. A float switch or probe installed at the destination OR a pressure switch in the discharge line will prevent the pump from running when there is no water demand.



Term	Definition
Voc (V)	Volts - open circuit, nothing connected
Vmpp (V) or Vmp	Volts - maximum power point, under load
Isc (A)	Amps - short circuit
Impp (A) or Imp	Amps - maximum power point
DC Power in W	Vmp x Impp
MPPT	Solar Maximum Power Point Tracking

3. Key information Guide

- Solar Array Sizing – Section 10, Pages 10 - 12
- Using the programming keypad – Section 14, Pages 19 and 20
- Programming – Section 16 Pages 23 -29

F2.01	Motor Rated Power	0.4 -11kW	Varies according to the Controller Model	F2.00~F2.06 must be set according to motor nameplate		0x201
F2.02	Motor Rated Voltage	1 - 480V				0x202
F2.03	Motor Rated Current	0.1 - 50.0A				0x203
F2.04	Motor Rated Frequency	F0.10				0x204
F2.05	Motor Rated Speed	1- 65000rpm				0x205
F2.06	Quantity of Poles	2 ~ 48 2 pole = approx. 2900rpm 4 pole = approx. 1450 rpm	4		0x206	

- For Solar specific applications, parameter group FD is the most important.

FD.06	MPPT Voltage Set Value		530V			0xD05
FD.10	MPPT VOC	250.0V – 800.0V	750.0V	Set to array VOC		0xD09

4. Contents

1. Introduction	2
2. Key Features and Protections.....	3
3. Key information Guide	4
4. Contents	5
5. Technical Specifications.....	6
6. Dimensions	7
7. Symbols used in this manual	7
8. Warnings and Cautions	8
9. Solar array selection	9
10. Solar array installation.....	12
11. Electrical Connections.....	13
12. Flexi Solar installation.....	15
13. Display Introduction.....	17
14. Controller Programming.....	19
15. Power On and Commissioning	20
16. Programming Groups and Parameter Details/Defaults.....	22
17. Controller Error Codes.....	29
18. Maintenance	32
19. Trouble Shooting Guide	33
20. Warranties – Terms and Conditions.....	34

5. Technical Specifications

	2.2	4.0	7.5	11.0
DC Input power				
Maximum Voltage	450V	800V		
Startup voltage	100V	220V		
Lowest Voltage	70V	200V		
Recommended MPPT Voltage	200 – 450V	400-750V		
Best working voltage	330V	560V		
DC Input circuits (MC4)	1		2	
AC Input power				
AC Input voltage Range	150 – 230V to L,N terminals	280 – 440V To R,S,T terminals		
AC Input Frequency	50/60 Hz			
Output Power: 3 phase AC				
Output Voltage	3 phase 230V +/- 15%	3 phase 415V +/- 15%		
Rated current	9.6 amps	9.0 amps	17 amps	26 amps
Output power	2.2	4.0	7.5	11.0
Output Frequency	50/60 Hz			



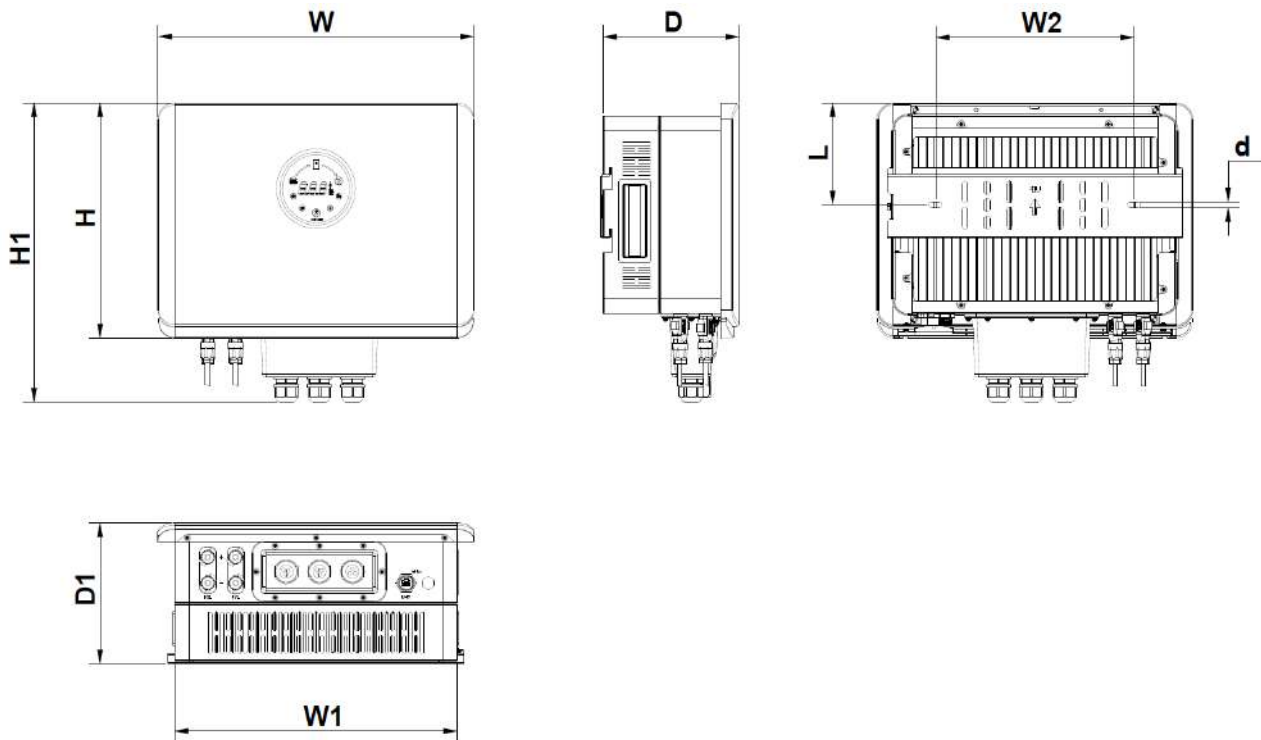

Control Performance	
Control Mode	SVC (Sensorless Vector Control) Mode - Default V/F Mode (Constant torque)
Motor type	Asynchronous Motor or Permanent Magnet Synchronous Motor
Overload	120% of rated current for 1 minute 150% of rated current for 10 seconds
IP Rating	I.P.65
Cooling	Natural air cooling
Working temp	Ambient temp -20 to 60° C. Practical maximum working temp without derating: 45° C Note: Installation in a shaded location is recommended
Altitude	Maximum 3000m elevation Above 2000m, de-rate by 1% for 100m additional altitude

6. Dimensions









Model	External Dimensions						Installation dimension		Hole size
	W	H	D	W1	H1	D1	W2	L	d
2.2kW 230V 3ph	396	295	180.5	360	371	184	270	140	8
4.0kW 415V 3ph									
7.5.0kW 415V 3ph	430	315	186	385	401	189	270	137	8
11.0kW 415V 3ph									

7. Symbols used in this manual

	Warning - Electrical safety
	Warning – Potential consequences of use outside of intended application(s). Includes environmental condition warnings.
	Mandatory warning
	Warning to disconnect power
	Read carefully

8. Warnings and Cautions

	<p>Read the manual carefully before starting and retain for future reference.</p>
	<p>Any changes or modification to the wiring must be carried out by competent, skilled and suitably qualified personnel only.</p>
	<p>A qualified electrician should correctly size and install circuit breakers to protect the power supply. The fitment of additional surge protection is recommended.</p>
	<p>This appliance is not intended for use by persons (including children) with reduced physical, sensory or mental capabilities, or lack of experience and knowledge, unless they have been given supervision or instruction concerning use of the appliance by a person responsible for their safety. Children should be supervised to ensure that they do not play with the appliance.</p>
	<p>Prior to starting installation or maintenance the controller must be disconnected from the power supply. Allow 5 minutes for the internal electronics to discharge before opening the cover</p>
	<p>Ensure the controller is a suitable size for the pump motor (see Section 5 :Technical Data). Size according to rated FLC.</p>
	<p>Avoid installing the nXt Flexi-Solar where it could experience the following conditions:</p> <ol style="list-style-type: none"> i. Where there is significant vibration and/or mechanical shock. ii. Where it could be exposed to corrosive liquids or gasses, or to flammable materials, solvents etc. iii. Extreme heat and cold. Operating range 0°C - 44°C. iv. Protect the controller from rain, moisture, humidity or dust

9. Solar array selection



Before starting a selection, ensure that you have accurate data about the solar panels you intend to use.

- Maximum power voltage V_{mpp} or V_{mp} – the panel voltage under load
- Open Circuit voltage V_{oc} – the panel voltage without load

The size of the solar array required is driven by three key factors

- Achieving or exceeding the necessary V_{mpp} Voltage
- Ensuring the maximum V_{oc} limit is not exceeded
- Ensure the wattage available is sufficient for the pump to achieve the required duty.

Note that pump efficiency (both electrical and hydraulic) will impact on the selection

DC Input Voltage Guidelines

NXT FLEXI-SOLAR 22 – Rated output current 9.6A DC Input power		
Maximum input Voltage (V_{oc})	450V	FLEXI-SOLAR 2.2 accepts a single input of a single string of solar panels connected in series.
Effective V_{MPP} voltage Range	200 – 450V	
Best working V_{MPP} voltage	330V	
Startup V_{MPP} Voltage	100V	
Lowest V_{MPP} Voltage	70V	

NXT FLEXI-SOLAR 40 DC - Rated output current 9.0A Input power		
Maximum input Voltage (V_{oc})	800V	FLEXI-SOLAR 4.0 accepts a single DC input of a string of solar panels connected in series.
Effective V_{MPP} voltage Range	440 – 750V	
Best working V_{MPP} voltage	560V	
Startup V_{MPP} Voltage	220V	
Lowest V_{MPP} Voltage	200V	

NXT FLEXI-SOLAR 75 - Rated output current 17A DC Input power		
Maximum input Voltage (V_{oc})	800V	FLEXI-SOLAR 7.5 has twin DC power inputs. Two separate strings of panels connected in series are required.
Recommended V_{MPP} Voltage	440 – 750V	
Best working V_{MPP} voltage	560V	
Startup V_{MPP} Voltage	220V	
Lowest V_{MPP} Voltage	200V	

Example 1:

400W solar panel
Voc 41 volts
Vmpp 34 volts

FLEXI-SOLAR 22
Maximum VOC 450V
Minimum Vmpp 200V

2.2kW P2 Pump
230V 3Ph
FLC 7.4 Amps

Step One

200V minimum input voltage / 34 Vmpp per panel = 5.88 panels. Round the answer up.

A minimum of 6 panels will be required to achieve the necessary **voltage**

Step Two

450V maximum input voltage / 41 Voc = 10.97 panels. Round the answer down

To stay under the maximum voltage value, the user should not use more than 10 panels

Excessive voltage or current can cause serious harm or irreparable damage voiding warranty.

Step Three

Multiply the pump P2 wattage by 1.3 for a minimum solar array wattage.

2200W x 1.3 = 2860W.

2860W / 400W panels = 7.15 panels.

For best results, round the result up but ensure the size of the array does not exceed the maximum panels from Step Two.

The solar array for this pump could be anywhere from 8 – 10 of these 400W panels

Example 2:

400W solar panel
Voc 41 volts
Vmpp 34 volts

FLEXI-SOLAR 40
Maximum VOC 800V
Minimum Vmpp 440V

4.0 kW P2 Pump
415V 3Ph
FLC 7.3 Amps

Step One

440V minimum input voltage / 34 Vmpp per panel = 12.94 panels. Round the answer up.

A minimum of 13 panels will be required to achieve the necessary **voltage**

Step Two

800V maximum input voltage / 41 Voc = 19.51 panels. Round the answer down

To stay under the maximum voltage value, the user should not use more than 19 panels

Step Three

Multiply the pump P2 wattage by 1.3 for a minimum solar array wattage.

4000W x 1.3 = 5200W.

5200W / 400W panels = 13 panels.

Round the result up but ensure the size of the array does not exceed the maximum panels from Step Two.

The solar array for this pump could be anywhere from 13 to 19 of these 400W panels.

Example 3:

400W solar panel
Voc 41 volts
Vmpp 34 volts

FLEXI-SOLAR 75
Maximum VOC 800V
Minimum Vmpp 440V

5.5 kW P2 Pump
415V 3Ph
FLC 9.8 Amps

Step One

440V minimum input voltage / 34 Vmpp per panel = 12.94 panels. Round the answer up.

A minimum of 13 panels will be required to achieve the necessary **voltage**

Step Two

800V maximum input voltage / 41 Voc = 19.51 panels. Round the answer down

To stay under the maximum voltage value, the user should not use more than 19 panels

The FLEXI-SOLAR 7.5 uses twin DC inputs so the maximum would be 2 strings of 9 panels each connected in series

Step Three

Multiply the pump P2 wattage by 1.3 for a minimum solar array wattage.

5500W x 1.3 = 7150W.

7150W / 400W panels = 17.88 panels.

For best results, round the result up but ensure the size of the array does not exceed the maximum panels from Step Two.

The solar array for this pump is 18 of these 400W panels – connected as 2 strings

Example 4:

440W solar panel
Voc 52.2 volts
Vmpp 44.0 volts

FLEXI-SOLAR 40
Maximum VOC 800V
Minimum Vmpp 440V

4.0 kW P2 Pump
415V 3Ph
FLC 7.3 Amps

In this example the solar panel output is higher.

Step One

440V minimum input voltage / 44.0 Vmpp per panel = 10 panels.

A minimum of 10 panels will be required to achieve the necessary **voltage**

Step Two

800V maximum input voltage / 52.2 Voc = 15.32 panels. Round the answer down

To stay under the maximum voltage value, the user should not use more than 15 panels

Step Three

Multiply the pump P2 wattage by 1.3 for a minimum solar array wattage.

4000W x 1.3 = 5200W / 440W panels = 11.81 panels. Round the result up but ensure the size of the array does not exceed the maximum panels from Step Two.

The solar array for this pump could be anywhere from 12 to 15 of these 440W panels.

10. Solar array installation.

SOLAR ARRAY

- The Solar array must face True North.
- The solar panel angle should correspond to the latitude of the site. Consult the instructions supplied with the solar array to assist your decision regarding the best angle for your situation.

As a general rule, solar panels should be more vertical during winter to gain most of the low winter sun, and flatter during summer to maximize the output.

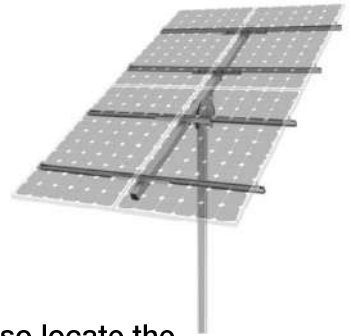

- Protect the array and controller from stock.
- Any shading whatsoever will reduce the solar panel(s) performance so locate the panels with this in mind. Panel shadowing is like “open circuiting” a panel.
- Dust or bird droppings will impair the array energy output. Keep panels clean.
- Ensure the array is earthed to ground in the event of lightning strike

To minimise energy losses the following chart provides recommended cable sizes.

White International recommend the installer perform their own calculations to satisfy themselves the cable sizing is correct, targeting a maximum voltage drop of 3%.

Solar Panel Input			Cable Length (Up to 'X' meters)									
DC Input Watts	Vmpp Volts	Imp Amps	10	25	50	75	100	125	150	200	250	300
1760	176	10	1.5	2.5	6	10	10					
2200	220	10	1.5	2.5	4	6	10	10				
2640	264	10	1.5	2.5	4	6	6	10	10			
3080	308	10	1.5	1.5	4	4	6	10	10	10		
3520	352	10	1.5	1.5	2.5	4	6	10	10	10		
3960	396	10	1.5	1.5	2.5	4	4	6	6	10	10	

Losses less than 3%	1.5	4mm ² cross section cable	<div style="display: flex; justify-content: space-around; align-items: center;"> <div style="width: 20px; height: 10px; background-color: #f08080; border: 1px solid black;"></div> 10mm² cross section Up to 5% losses <div style="width: 20px; height: 10px; background-color: #ff0000; border: 1px solid black;"></div> Larger than 10mm² required </div>
	2.5	6mm ² cross section cable	
	4	4mm ² cross section cable	
	6	6mm ² cross section cable	
	10	10mm ² cross section cable	

ROOF MOUNT ARRAY (NZ Only):

Because the most common structure is a wooden frame, the panels and mounting system have no direct path to earth. In the event of lightning strike, the earth path is entirely via the combiner box.

- Install a minimum 6mm² earth strap to a ground stake.

GENERATOR SIZING:

Multiply the pump P2 kW by 1.5 for the minimum generator output power.

11. Electrical Connections

Install with a suitably rated circuit breaker

All wiring must be carried out by a suitably qualified technician.

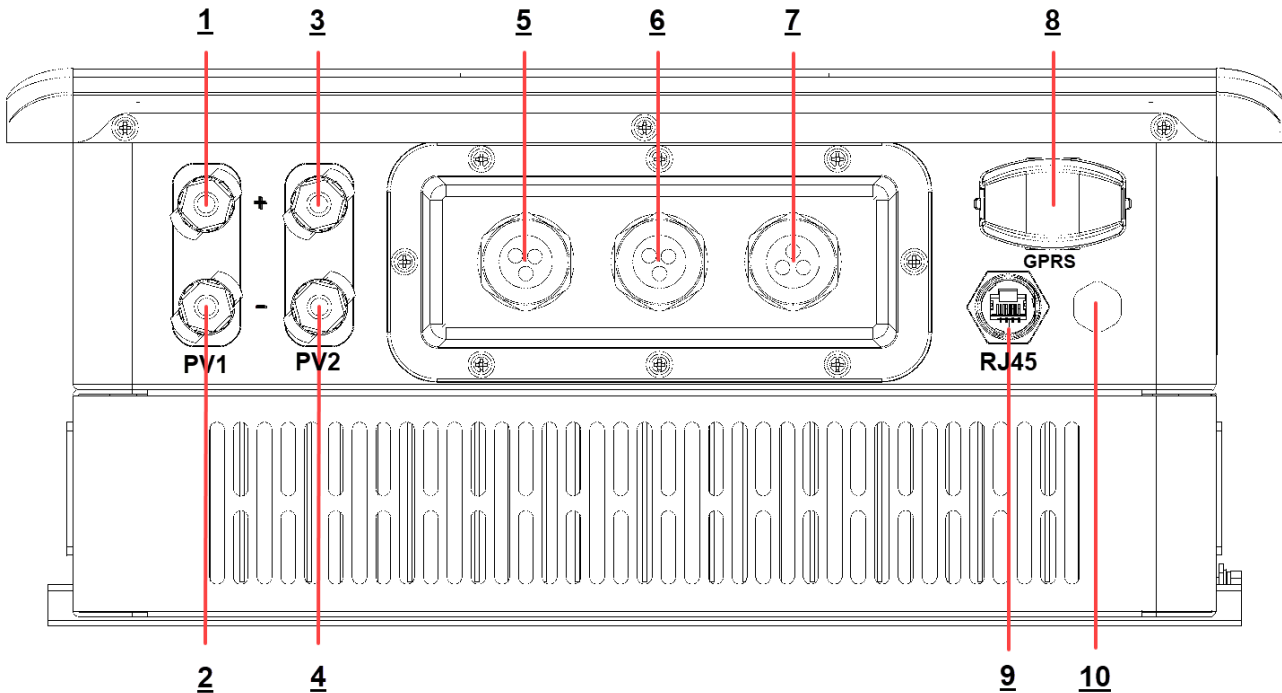

Item	Port Name	Description	Technical Features
1	PV1+	1st PV Panel Positive Input Port	≤20A
2	PV1-	1st PV Panel Negative Input Port	≤20A
3	PV2 +	2nd PV Panel Positive Input Port (only available on 5.5-11kW models)	≤20A
4	PV2 -	2nd PV Panel Negative Input Port (only available on 5.5-11kW models)	≤20A
5	AC Input	AC input can be connected to mains grid or a generator Input voltage model dependent	Single Phase 230V OR 3 Phase 415V
6	AC Output	Can be connected to pumps with ordinary asynchronous motor or permanent magnet synchronous motor (PMSM) Default: 3 Phase Asynchronous Motor F2.00	3 Phase 230V or 415V
7	Signal Port	For water level signal wire or communication wire	
8	GPRS Module Port	USB-A: Optional port to allow connection of remote monitoring comms module	
9	External KeypadPort	Optional external keypad for parameter adjustment	
10	Breather Valve	Keeps pressure balanced inside and outside the machine and prevents condensation	

Symbol	Name	Technical Specifications
R/L, S, T/N	AC INPUT Terminals	R/L and T/N for single phase 230V input R/L, S and T/N for 3 phase 415V input
PE	Ground Terminal	Power Input and Motor Output ground terminal
U,V,W	AC OUTPUT Terminals	The 3-phase pump motor connects to the U/V/W output terminals respectively.
DI1, DI2, DI3	Multi-functional Digital Input Terminals	Optocoupler isolated unidirectional input ON when closed circuit to GND, OFF when open circuit to GND Input voltage range: 9~36VDC Input impedance: 4kΩ
24V	Analog Reference Voltage	24V, ±5%, Maximum output current 100mA
+10V	Analog Reference Voltage	10V, ±5%, Maximum output current 50mA
AI	Analog Input Terminal	Default as 4~20mA input. Can be set to 0-10V input. Default resistance 500Ω.
GND	Analog GND	Reference zero potential of the analog reference voltage.
S+ / S0 / S-	Communication Port for Multi Drive System (CAN Protocol)	Standard CAN communication interface Use twisted pair or shielded wire and connect S+, S0, S- when building multi-drive systems



The power supply from a DC power source such as solar panels can cause **SERIOUS HARM** or **DEATH** from electrocution

- Use appropriate safety procedures when working on any system component
- Only suitable qualified personnel should carry out electrical connection/disconnection
- Always treat solar panels as LIVE and handle with care
- Use correctly rated electrical cable and connectors
- **Off-grid electrical equipment is subject to applicable regional and national electrical standards**



12. FLEXI-SOLAR installation

FLEXI-SOLAR has an IP65 rating but avoid installing the controller exposed to direct sunlight or weather. Installing under the solar panels will provide protection.

Ambient temperature should be maintained in the range 0-45 deg C and humidity between 20 to 90%. At higher temperatures the output of the controller will be de-rated

When installing and moving, please hold the bottom of the product, not just the casing, to prevent injury or damage to the controller.



Lift Handles

DC Input Power Wiring: PV1 (PV2)

The solar array will include a 'combiner box'. Connect the PV+ output from the combiner box to the PV+ input on the Flexi-Solar. Connect the PV- output from the combiner box to the PV- input on the Flexi-Solar.

The Flexi-Solar 22 and 4.0 accept a single DC input. The larger models accept twin DC inputs.



Ensure the solar array does not exceed the maximum VOC input voltage.

AC Input Power Wiring (Generator)

Remove the junction box in the middle of controller bottom.

Pass the AC input wire through the cable gland.

- Connect input single-phase AC to the R/L and T/N terminal of the machine,
- Connect three-phase AC to the R/L and S and T/N terminal, and
- The ground wire is connects to the PE terminal.



Motor Wiring

Connect 4 cables from the motor to the U, V, W, PE terminals of the controller through the water-resistant gland on the junction box.

Ground Wiring

The ground terminal on the controller is marked as PE and **MUST** be connected to earth. In the event of motor failure, proper grounding helps eliminate the risk of electric shock.

Low Level Float Switch Wiring (Optional) **DI2 / GND**

In order to avoid damage to the pump caused by dry running, a source water level float can be connected to the DI2 & GND terminals of the Flexi-Solar.

Ensure the float delivers a **closed** signal to DI2 and GND terminals when water level is too low.

Note that '3 wire' floats allow for NO or NC wiring so connect to the controller using the black and blue wires. The circuit will be open when the float is up, and closed circuit when the float is down

There is a water shortage detection function within the controller software but it is far better that the controller prevents the pump from attempting to run when no water is present.

The length of the float cable should not exceed 50m.

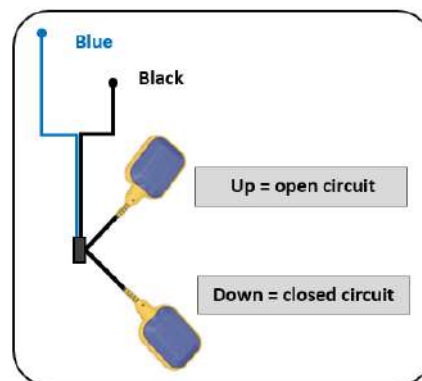

High level Float Switch Wiring (Optional) **DI3 / GND**

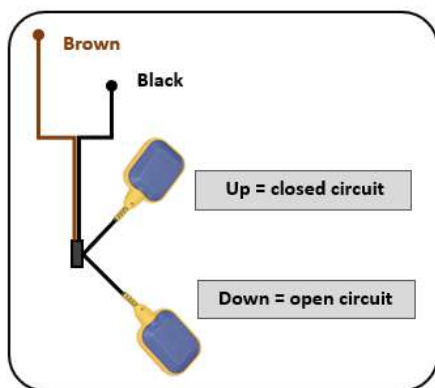

We recommend using a float switch to prevent the reservoir from overflowing, the pump will stop when the reservoir is full. The pump will restart when it falls below the low water level. It prevents overflow and reduces unnecessary pump wear. The solar water pump PDS51 controller allows the use of small signal wires to connect a remote float switch, even if the reservoir is located far away.

Electrical Conduit

Electrical conduit should be used to protect wiring.

The controller can be powered on after the wiring is completed and the cover is installed.

Wait at least 10 minutes after the power is turned off before maintenance and inspection, otherwise personal injury may occur. Never remove the cover when the power is on

Note : To ensure maximum reliability of the system and water supply, non-return check valves must be installed in the output pipe. The first check valve must be installed on the water pump outlet, Additional check valves should be installed on the discharge piping every 30 meters (vertical) after the pump

Check the rotational direction of the water pump.

Best practice is to ensure the pump has some water internally to lubricate the mechanical seal. Avoid running the pump without water for longer than 15 sec

If the rotation of the water pump is incorrect, reverse any two of the three pump power supply cables (controller output side).

13. Display Introduction

Using the display screen, the controller can be stopped or started its working status can be monitored. Programming is achieved using an external keypad.

Controller programming cannot be accessed via the main display



To Start or Stop, Press and Hold for 3 sec

Short Press to scroll and view display parameters

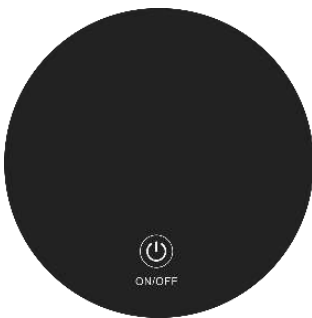

Controller Off
Stop/Start button flashes



DC Input Run Mode
Green light ring rotates



AC Input Run Mode
Solar array disconnected



DC Input sleep Mode
Green light ring flashes

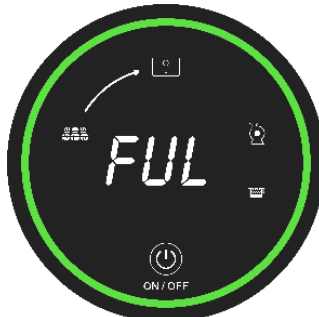



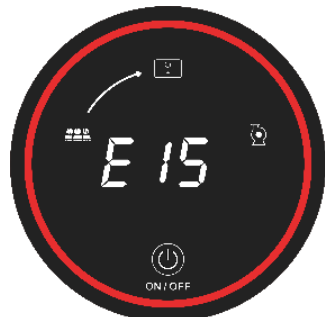









Destination Full state
Indicator displayed



Controller Alarm
Red light ring flashes

13a. Display Introduction con't

Icon	Name	Function
	Controller State Indicator	The colour and behaviours of the outer ring provides a clear indication of the Controller Status
	Solar Array Indicator	This icon displays in the 10 o'clock position when there is a DC power input
	Input Power Indicator	This icon displays in the 12 o'clock position when the controller is powered on
	Pump Indicator	This icon displays in the 2 o'clock position when the controller is able to run the pump
	Communication Indicator	When this indicator displays, it means that the GPRS module is connected, and the communication is successful. If it is flashing, it means that the communication has failed. When it is off, it means that the GPRS module is disconnected.
	Multi-Drive Indicator	This icon will only display if the controller has been configured for Multi-Drive mode. The icon does not indicate that communication is occurring, only that the controller is configured as Multi-Drive
	Low Level indicator (source)	Requires a Low-level probe or float installed at the source. When the source water level is too low, the low-level indicator and the LOU water shortage fault will display;
	Tank full indicator (destination)	Requires a float or pressure switch installed to control water delivery to the destination. When switch indicated that no more water is required, the controller tank full indicator will light up, and the word FUL will be displayed
	Stop Start button	In the working state, Press and Hold for 3 seconds to start or stop the controller. Short press will scroll through the 4 main running state parameters (see below)
	Output Current	Controller output current in Amps
	Bus Voltage	Inner bus voltage (a DC voltage value equal to input DC voltage, OR input AC voltage multiplied by 1.414)
	Running Frequency	Pump running frequency in Hertz
	Output Power	Controller output power i.e. pump (P1 value)

14. Controller Programming



Programming should only be carried out by suitably trained personnel. Parameters randomly modified or altered in error can induce abnormal operation and have the potential to harm the controller as well as the water supply system, or even to cause personal injury or accidents.

NXT FLEXI-SOLAR programming is achieved using a handheld, removable keypad supplied with every unit.

Connection between external keypad and the FLEXI-SOLAR is achieved using a RJ45 comms cable.

The comms cable supplies power to the programming interface.

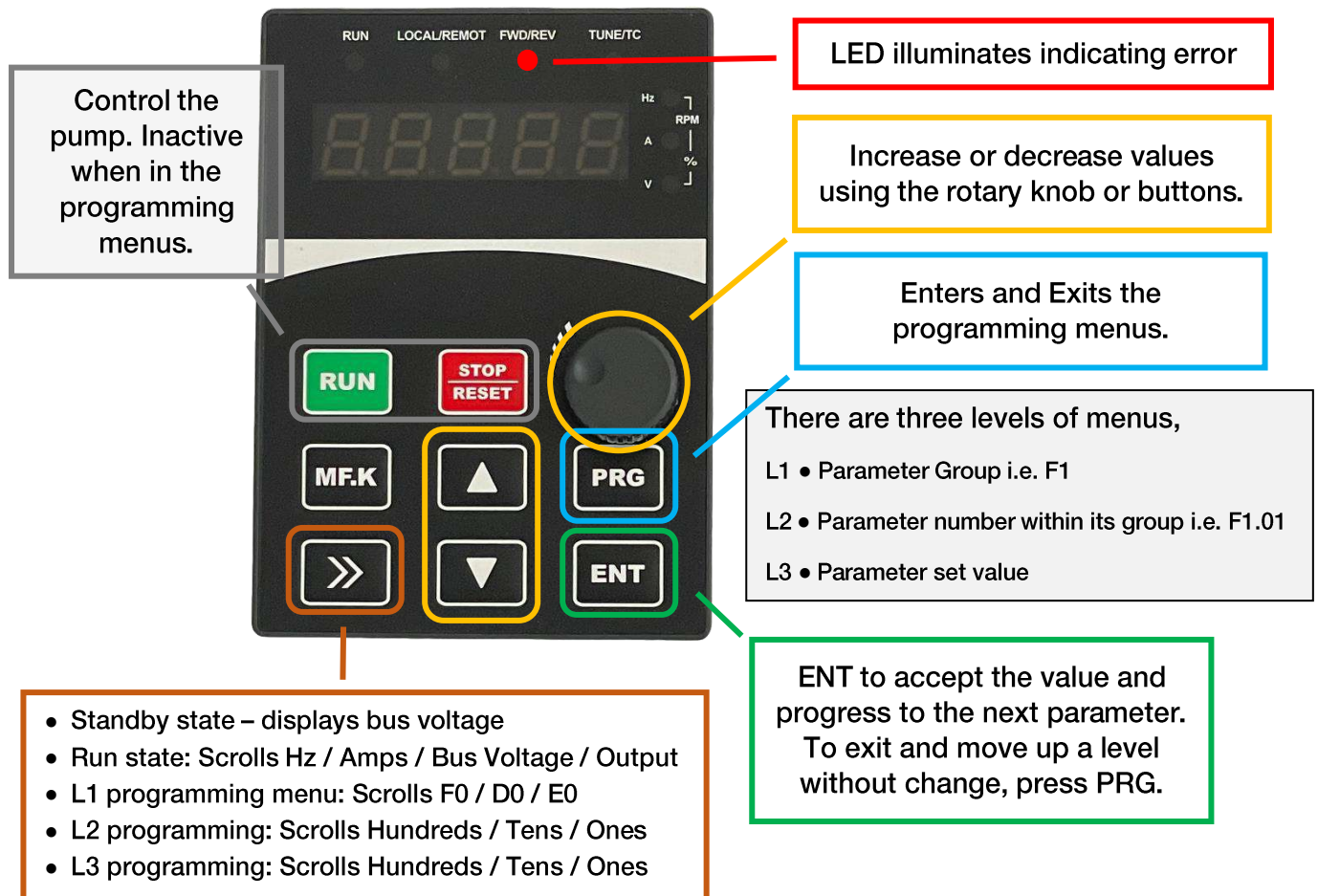

Keeping a record of any changes to the program parameter values is highly recommended and will assist fault finding

14a. Controller Programming con't

Example: Setting the rated motor power in Parameter Group 2, address F2.01

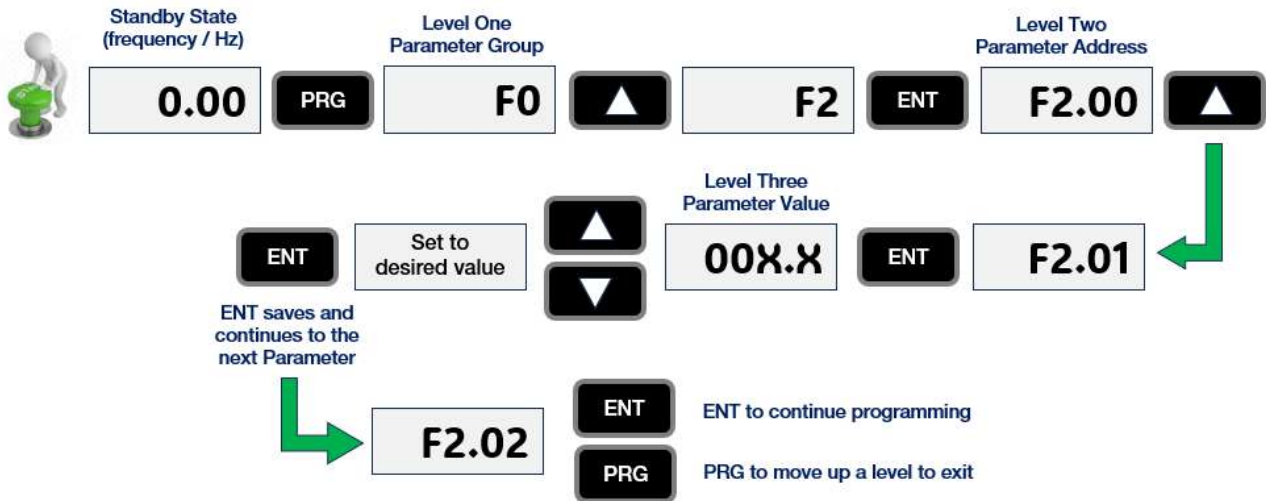

If the controller is behaving in an unusual manner, it is highly possible that a parameter has been altered in error. In this event, navigate through each Group and every Parameter, resetting to factory default values.

Afterwards recommence programming from the very beginning.

15. Power On and Commissioning

- 1 Check and ensure all wiring is correct.
 - Check motor and cable insulation with a megger;
 - Use a multi-meter to check whether the Voc of the solar panels from the DC switch meets the requirements or not;
 - Close the DC switch to power on the controller;
- 2 If necessary, modify and set the parameters of the motor as follows:

Other related parameters are: motor rated power F2.01, motor rated voltage F2.02, motor rated current F2.03, motor rated frequency F2.04, motor rated speed F2.05.

The default motor rated frequency is set as 50Hz.

60Hz rated motors will require the following parameters to be modified:

- F0.10 maximum output frequency= 60.00
- F0.12 upper limit of running frequency = 60.00,
- F2.04 motor rated frequency = 60.00

Check the rotation direction of the water pump

Press the START/STOP button to start the motor briefly and slowly to check whether the rotation of it is correct.



If the pump is in a dry running state, the maximum running time should not exceed 15s, otherwise the pump mechanical seal may be damaged.

If the direction is wrong, turn off the DC switch, then swap any two of the 3 cables connecting the motor and controller U/V/W ports.

Stop to check the displayed bus voltage of the controller or use a multi-meter to measure the PV open-circuit voltage, and set **FD.10 = Actual open-circuit voltage value.**

Trial operation, let the system work for one hour, check the water supply capacity, if there is no problem, the commissioning is completed.

Note: When the light is insufficient, the output power of the solar panels will be reduced, and the water pump will run very slowly until it stops. The controller will try to start every 300 sec (Parameter FD17), and the running indicator light will stay on during the time it tries to run. When a shadow suddenly passes through the solar array, the controller will lose track of the input voltage and the pump will stop working. The controller will not display any fault rather it will initiate its pump restart procedure

The default motor rated frequency is set as 50Hz.

60Hz rated motors will require the following parameters to be modified:

- F0.10 maximum output frequency= 60.00
- F0.12 upper limit of running frequency = 60.00,
- F2.04 motor rated frequency = 60.00

Check the pump rotation direction. If the direction is wrong, turn off the DC switch, then swap any two of the 3 cables connecting the motor and controller U/V/W ports.

Stop to check the displayed bus voltage of the controller or use a multi-meter to measure the PV open-circuit voltage, and set **FD.10 = Actual open-circuit voltage value.**

Program parameter hierarchy

	Essential parameter – input value for motor and solar array
	Important parameters – alter according to site specific requirements
	Common fine-tuning parameters
	Parameters to access advanced options.
	Advanced settings. Alter with care as unexpected behaviours may occur

16. Programming Groups and Parameter Details/Defaults



Parameter can be altered whether the controller is stopped or running.







Controller must be stopped to change parameter.



Measured value or manufacturer's default which cannot be changed.











F0 Basic Parameters (31 parameters total – 20 related to Flexi-Solar pumping operation)



Address	Name	Setting Range	Default	Remarks		Comms Address
F0.00	Motor Control Mode	0 : SVC 1 : V/F	1			0x000
F0.01	Start/Stop Source Option	0 : Start/Stop Button 1 : Terminal 2 : RS485 Communication	0			0x001
F0.02	Control Mode	0 : Speed Control 1 : Torque Control	0			0x002
F0.03	Main Frequency Source	0: Keypad Not retained after power-off 1: Keypad, Retained after power-off 2: AI1 3 to 6: Reserved 7: Terminal UP/DOWN 8: MPPT 9: RS 485 Communication 10: Multi-Drive Comms	8	Tune Parameter Group FD for Solar Specific applications		0x003
F0.04	Auxiliary Frequency Source	0: Keypad, Not retained after power-off 1: Keypad, Retained after power-off 2: AI1 3 to 6: Reserved 7: Terminal UP/DOWN 8: MPPT 9: RS 485 Communication 10: Multi-Drive Comms	1			0x004
F0.08	Keypad Setting Maximum Frequency	0.00 to F0.10	50.00Hz			0x008
F0.09	Motor Rotation Direction	0 : FWD 1 : REV	0			0x009
F0.10	Maximum Output Frequency	50.00 ~ 320.00Hz Do not exceed motor rated frequency	50.00Hz	Motor rated Hz		0x00A
F0.12	Upper Limit of Running Frequency	F0.14 to F0.10	50.00Hz	System maximum Hz		0x00C
F0.14	Lower Limit of Running Frequency	0.00 to F0.12	0.00Hz	Tune minimum speed using FD parameter group		0x00E

Address	Name	Setting Range	Default	Remarks		Comms Address
F0.15	Running Mode at F0.14	0: Standby (Sleep) 1: Running at F0.14 2: Stop	0			0x00F
F0.16	Carrier Frequency	0.5 ~ 15.0kHz	Model Dependent	8.0 as maximum for SVC mode		0x010
F0.18	Acceleration Time1	0.0 ~ 6500.0s	Model Dependent			0x012
F0.19	Deceleration Time1	0.0 ~ 6500.0s	Model Dependent			0x013
F0.20	Recovery option	0: No Option 1: Recover all default settings, except F2 team 2: Clear all error (alarm) records 3: Recover all default settings, including F2 parameter group	0	Use with caution		0x014

F1 Reserved group – **DO NOT ALTER** (37 parameters)

F2 Motor Parameters (41 parameters total – 13 related to Flexi-Solar pumping operation)



Address	Name	Setting Range	Default	Remarks		Comms Address
F2.00	Type of Motor	0 : 3 Ph Asynchronous Motor (AM) 1 : 3 Ph Permanent Magnet Synchronous Motor (PMSM) 2 : Single Phase Motor	0			0x200
F2.01	Motor Rated Power	0.4 - 11kW	Varies according to the Controller Model	F2.00~F2.06 must be set according to motor nameplate		0x201
F2.02	Motor Rated Voltage	1 - 480V				0x202
F2.03	Motor Rated Current	0.1 - 50.0A				0x203
F2.04	Motor Rated Frequency	As per F0.10				0x204
F2.05	Motor Rated Speed	1- 65000rpm				0x205
F2.06	Quantity of Poles	2 ~ 48 2 pole = approx. 2900rpm 4 pole = approx. 1450 rpm			4	
F2.07	Motor No-Load Current	0.1 - 50.0A	Varies according to the Controller Model			0x207
F2.08	Motor Stator Resistance	0.001 - 65.000			0x208	
F2.09	Motor rotor resistance	0.001 - 65.000			0x209	

Address	Name	Setting Range	Default	Remarks		Comms Address
F2.10	Motor Leakage Inductance	0.1 - 6500.0mH	Varies according to the Controller Model			0x20B
F2.11	Motor Mutual Inductance	0.1 - 6500.0mH				0x20B
F2.12	Motor Tuning Option	0 : No Option 1 : Full-Tuning 2 : Quiet-Tuning	0	Option 1 for the motors which can be totally removed from their load Option 2 for the motors which cannot be totally removed from their load		0x20C

F3 Reserved group – **DO NOT ALTER** (45 parameters)



F4 Reserved group – **DO NOT ALTER** (56 parameters)

F5 Function of DI Terminals (40 parameters total – 3 related to Flexi-Solar pumping operation)

Address	Name	Setting Range	Default	Remarks		Comms Address
F5.00	DI1 Function	0 : No Option 1 : FWD Running (FWD)	1			0x500
F5.01	DI2 Function	4 : FWD Jog (FJOG) 9 : Error Reset (RESET) 11 : External Alarm (NO signal) input	47			0x501
F5.01	DI3 Function	47 : Well Low Level Input 48 : Water Tank Full Input	48			0x502

F6 Reserved group – **DO NOT ALTER** (8 parameters)

F7 Controller Features (11 parameters total – 2 related to Flexi-Solar pumping operation)

Address	Name	Setting Range	Default	Remarks		Comms Address
F7.08	IGBT Temp	0 – 100 deg C				0x708
F7.09	Software Version					0x709

F8 Reserved group – **DO NOT ALTER** (17 parameters)



F9 Reserved group – **DO NOT ALTER** (16 parameters)

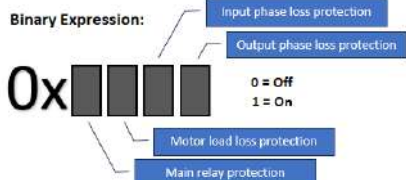













FA Alarm and Protection

Address	Name	Setting Range	Default	Remarks		Comms Address
FA.00	Motor overload warning factor	20 – 250%	80%		☆	0xA00
FA.01	Motor overload protection factor	20.0 - 250%	100%		☆	0xA01
FA.02	Fault Self recovery interval	0.1 – 100.0sec	30.0 sec		☆	0xA02
FA.03	Over voltage stall gain	0 - 100	1	10		0xA03
FA04 – FA07 not used						
FA.08	Phase Loss protection	<p>Binary Expression:</p> 	0x0011		☆	0xA08
FA09 – FA19 not used						
FA.20	Fault self recovery times	0 - 5	3	Select 1 to 5 to enable automatic fault reset operation. When there is a fault during operation, the fault will be reset automatically after fixing for 10S.	☆	0xA14
Water shortage, disconnection, high and/or low voltage, pipe burst, external fault, time arrival fault are not affected by function code FA20						

FD Specific Solar Pump Controller Parameters



(50 parameters total – 32 related to Flexi-Solar pumping operation)

Address	Name	Setting Range	Default	Remarks		Comms Address
FD.00	Solar Pump Running option	0 = Invalid 1 - Valid	1			FD00
FD.01	Running mode option	0: PV Input Mode 1: PV Priority Mode 2: Power Priority Mode	1			0xD00
	0: PV input refers to only PV DC power supply (No AC input) 1: PV priority mode means that when AC and DC input power are both connected at the same time, the PV power will be used first, and the AC will be automatically connected when the PV power is insufficient. 2: Power priority mode, when AC and DC input are both connected at the same time, real-time power complementation ensures maximum power output.					
FD.02	System Mode	0 : Single Drive Mode 1 : Multi Drive Mode	0			0xD01









Address	Name	Setting Range	Default	Remarks		Comms Address
FD.03	Host and Auxiliary Setting in Multi Drive System	0 : Host 1 : 1st Auxiliary 2 : 2nd Auxiliary	0			0xD02
FD.04	Screen off delay	0 min – 1000 min (16.7 hrs)	30 min	0 = Never off		0xD03
FD.05	MPPT Voltage Source	0 : Keypad Setting 1 : Automatic MPPT Setting	1			0xD04
FD.06	MPPT Voltage Set Value		530V			0xD05
FD.07	Weak light detection time	0.0sec – 1000.0sec	100.0sec			0xD06
FD.08	Weak light restart time	0.0sec – 3600.0sec	300.0 sec			0xD07
FD.09	MPPT Startup Voltage Level	70.0% - 100.0%	85%			0xD08
FD.10	MPPT VOC	250.0V – 800.0V	750.0V	Set to array VOC		0xD09
FD.11	Auto Startup Option	0 = Invalid 1 - Valid	1			0xD0A
FD.12	Auto Startup Delay	0.0 sec – 100.0 sec	15.0 sec			0xD0B
FD.13	MPPT Initial Value Adjustment Range	0.0V – 50.0V	30.0V			0xD0C
FD.14	Software Dry Run Detection Delay	0.0 sec – 3600.0 sec	20.0 sec			0xD0D
FD.15	Water shortage detection frequency	0.0% - 100.0%	90.0%			0xD0E
FD.16	Software Dry Run Detection Current Percentage	0.0% – 100.0% of Motor Rated Current	40.00%			0xD0F
FD.17	Dry Run Restart Delay	0 min – 9000 min				0xD10

Address	Name	Setting Range	Default	Remarks		Comms Address
FD.18	Lower Limit of MPPT Voltage	250.0V to setting at FD19	500.0V			0xD11
FD.19	Upper Limit of MPPT Voltage	Setting FD18 to 800.0V	600V			0xD12
FD.20	Lower Limit of MPPT Frequency	0.0% to setting at FD21	40%			0xD13
FD.21	Upper Limit of MPPT Frequency	Setting FD20 to 100.0%	100.0%			0xD14
FD.22	MPPT Fast Deceleration Speed	0 – 200	100	Can be set higher if there is always weak light or low input voltage		0xD15
FD.23	MPPT Deceleration Time	0.0 sec – 6500 sec	0.5 sec			0xD16
FD.24	MPPT Adjust unit	0.0 – 30.0V	10.0V			0xD17
FD.25	Power Level for AC Input Coming in	0W – 3000W	1000W			0xD18
FD.26	Power Level for AC Input Coming Out	0W – 3000W	500W			0xD19
FD.29	Boost module voltage loop proportional gain coefficient	1 - 1000	50		☆	0xD1C
FD.30	Boost module voltage loop integral coefficient	1 - 1000	50		☆	0xD1D
FD.31	Voltage loop integral desaturation coefficient of boost module	1 - 1000	50		☆	0xD1E

FE User Preference

Address	Name	Setting Range	Default	Remarks		Comms Address
FE.00	User Password	0 - 65535	1	0		0xE00
FE.01	Error Record Displayed Teams	0 - 15	1	5		0xE01

E0 Latest Error Record (12 parameters)

E0.00	Error Codes			0xE000
<p>0 : No Error 1 : Reserved 2 : Overcurrent during acceleration (E02) 3 : Overcurrent during deceleration (E03) 4 : Overcurrent at constant speed (E04) 5 : Overvoltage during acceleration (E05) 6 : Overvoltage during deceleration (E06) 7 : Overvoltage at constant speed (E07) 8 : Snubber resistor overload (E08) 9 : Low input voltage (E09) 10 : Controller overload (E10) 11 : Motor overload (E11) 12 : Input phase loss (E12) 13 : Output phase loss (E13) 14 : IGBT overheat (E14) 15 : External alarm input (E15) 16 : Communication failure (E16) 17 : Snubber relay failure (E17) 18 : Current detection failure (E18) 19 : Motor tuning failure (E19) 21 : Parameter R/W failure (E21) 22 : EEPROM failure (E22) 23 : Motor short to ground (E23) 24 : Dry run alarm (E24) 26 : Running time reached (E26) 29 : Power-on time reached (E29) 30 : Load loss (E30) 40 : Fast current limit timeout failure (E40) 98/99: Communication failure between controller and external keypad (E98/E99)</p>				
E0.01	Running frequency at latest error			0xE001
E0.02	Output current at latest error			0xE002
E0.03	Bus Voltage latest error			0xE003
E0.04	DI Status at latest error			0xE004
E0.05	Reserved			0xE005
E0.06	Controller temp at latest error			0xE006
E0.07	Controller state at latest error			0xE007
E0.08 E0.09 E0.10 E0.11	~	RESERVED		0xE008 0xE009 0xE00A 0xE00B

E1 Reserved group – **DO NOT ALTER** (12 parameters)

E2 Reserved group – **DO NOT ALTER** (12 parameters)

17. Controller Error Codes

Even in bad weather conditions, nXt Flexi Solar will try to drive the water pump to lift water. To ensure reliable service life, system components must be protected from factors that can damage equipment. When severe conditions arise, the controller reduces output if necessary, and continues to pump water for as long as possible only shutting down in extreme conditions.

If the controller has stopped and an error code is shown on the screen, the delay depends on the nature of the fault. The number after the letter E corresponds to the error code

Code	Description	Possible Causes	Solutions
E02	Overcurrent during acceleration	There is grounding or short circuit in the output circuit of the controller	Eliminate peripheral faults and check whether there is a short circuit at the motor end
		Acceleration time is set too short	Increase acceleration time
		The controller model is too small (incorrect selection)	Select the controller that matches the motor power and load conditions
E03	Overcurrent during deceleration	There is grounding or short circuit in the output circuit of the controller	Eliminate peripheral faults and check whether there is a short circuit at the motor end
		Deceleration time is set too short	Increase deceleration time
E04	Overcurrent at constant speed	There is grounding or a short circuit in the output circuit of the controller	Eliminate peripheral faults and check whether there is a short circuit at the motor end
		Controller model is undersized	Select the controller that matches the motor power and load conditions
E05	Overvoltage during acceleration	Input voltage is too high	Adjust input voltage to a proper range
		Acceleration time is set too short	Increase acceleration time
		No braking unit and braking resistor installed	Install braking unit and braking resistor
E06	Overvoltage during deceleration	Input voltage is too high	Adjust input voltage to the correct range
		Deceleration time is set too short	Increase deceleration time
		No braking unit and/or braking resistor installed	Install braking unit and braking resistor
E07	Overvoltage at constant speed	Input voltage is too high	Adjust input voltage to a proper range
E08	Snubber resistor overload	The input voltage is not within the specified range	Adjust input voltage to a proper range
E09	Low input voltage	The input voltage is not within the specified range	Adjust input voltage to a proper range
		Abnormal bus voltage detection; abnormality of rectifier bridge, snubber resistor, drive board and/or control board	Seek technical support

17a. Controller Error Codes con't

Code	Description	Possible Cause	Solution
E10	Controller overload	Load is too great, or the motor is jamming	Reduce load and check motor and mechanical condition
		Controller model is too small	Select the controller that matches the motor power and load conditions
E11	Motor overload	The motor overload protection parameters (FA.01-FA.02) are not properly set	Set parameter settings
		Load is too great, or the motor is stuck	Reduce load and check motor and mechanical condition
E12	Input phase loss	Abnormal three-phase input power	Check and troubleshoot existing problems in peripheral circuits
		Failure of drive board or control board	Seek technical support
E13	Output phase loss	Motor failure	Check if the motor windings and assess whether the motor is in an operable state
		The wiring between controller and motor is abnormal	Troubleshoot peripherals
		When the motor is running, the three-phase output of the controller is unbalanced	Check whether the three-phase windings of the motor are normal and troubleshoot
		Failure of IGBT or drive board	Seek technical support
E14	IGBT overheat	Ambient temperature is too high	Take actions as appropriate to manage local ambient temperature
		Air duct blocked	Clear air duct
		Fan failure	Replace the fan
		Failure of thermistor or IGBT	Seek technical support
E15	External alarm input	Input external fault signal through DI terminal	Clear external fault signal
E16	Communication failure	The upper host machine is abnormal	Check the wirings between upper host and controller
		RS485 communication wire is abnormal	Check the communication wires
		Incorrect settings of communication parameter FC team	Correctly set communication parameters (communication address, baud rate, check bit)
E17	Snubber relay failure	The relay does not pick up	Replace the snubber relay or seek technical support

17b. Controller Error Codes con't

E18	Current detection failure	Abnormal current detection circuit	Seek technical support
		Control board failure	Seek technical support
E19	Motor tuning failure	Motor parameters. F2 parameters are not set according to the nameplate	Set motor parameters according to the nameplate
E21	Parameter R/W failure	Control board failure	Seek technical support
E22	EEPROM failure	EEPROM chip failure	Seek technical support
E23	Motor short to ground	The motor or controller output cable is short-circuited to ground	Measure the motor and output wire insulation with a megger
		Control board failure	Seek technical support
E24	Dry run alarm	Source water level low	Check and troubleshoot water level problem
		When FD.14 software dry run detection delay is a non-zero value, check whether the setting of FD.16 software dry run detection current percentage is too high	Decrease set value of FD.16
E26	Running time reached	Accumulated running time has reached set value	Clear log information using parameter initialization function
E29	Power-on time reached	Accumulated power-on time has reached set value	Clear log information using parameter initialization function
E40	Fast current limit timeout failure	Load is too great or motor is stuck	Reduce load and check motor and mechanical condition
		Controller model is undersized	Select the controller that matches the motor power and load conditions
E98/ E99	Inner communication failure	The cable connecting the control board and the screen isn't seated correctly	Re-plug the cable
		Screen failure	Seek technical support
Lou	Well low-level alarm	The low water level probe (or float switch) terminals of the water inlet is closed connecting DI2 and GND terminals	Check if the well is short of water
FUL	Water tank full alarm	The high-water level float switch terminals of the water outlet tank is closed, connecting DI3 and GND terminals	Check if the water tank is full

18. Maintenance

Periodic Maintenance

Operation can suffer if the controller suffers over-heating.

Ambient temperature should be maintained in the range 0-40 deg C and humidity between 20 to 90%.

Over the life of the controller, a build-up of dust or dirt can result in the controller operating at a higher temperature than normal.

The controller should be installed where airborne dust is minimised.

The cover should be removed periodically and vacuum or low pressure air used to remove any build-up of dust or dirt especially on the PCB's, on the fans and on the cooling plate/heatsink fins.

While the cover is removed, check the control terminal screws are tight.

19. Trouble Shooting Guide

The nXt Flexi-Solar controller continuously monitors the performance of the system and can detect various abnormal conditions. In many cases, the controller will provide compensation as needed to maintain uninterrupted running of the system. If there is a possibility of equipment damage, the controller will protect the system and display the fault status; if possible, the controller will restart after the fault status is eliminated.

Phenomenon	Possible Causes	Solutions
Power on but the display doesn't illuminate	Incorrect input power	Check input voltage is within the specified range
	The cable connecting the control board and the screen is making poor contact	Re-connect the cable
	The cable connecting the control board and the screen is damaged	Seek technical support
Pump cannot run	Insufficient input power (insufficient light)	Increase the power of panels or wait until the light is sufficient before restarting
	Motor failed or stuck	Replace motor or fix the mechanical issue
	Incorrect wiring	Check whether the wiring between the controller and the motor is correct
DI terminal failure	Incorrect parameter settings	Check and reset the F5 parameters
	Abnormal external signal	Check the external signal wire carefully to eliminate possible external input fault
	Control board failure	Seek technical support
Interruption from controller	Incorrect carrier frequency	Reduce the carrier frequency
	Improper or insufficient grounding	Ground the inverter and motor, and separate them from the grounding of any peripheral equipment
	Cables between controller and motor are too long or too undersized	Install output reactor or reduce cable length
Excessive motor noise	Motor damaged or mechanical failure	Replace the motor or fix the mechanical issue
	Improper carrier frequency	Increase the carrier frequency
Overload Switch tripping	RCD switch installed or the contactor is overloading	Use a switch with ground leakage protection or fit a contactor with a higher rating.
	Abnormal input power	Check input power for any short circuiting
	Controller internal failure	Seek technical support

20. Warranties – Terms and Conditions

This warranty is given in addition to the consumer guarantees found within the Australian Competition and Consumer Act 2010 (Cth) for goods purchased in Australia and the Consumer Guarantees Act 1993 NZ for goods purchased in New Zealand:



1) White International Pty Ltd / White International NZ Ltd (White International) warrant that all products distributed are free from defects in workmanship and materials, for their provided warranty period as indicated on the top or opposite side of this document. Subject to the conditions of the warranty, White International will repair any defective products free of charge at the premises of our authorised service agents throughout Australia and New Zealand if a defect in the product appears during the warranty period. If you believe that you have purchased a defective product and wish to make a claim under this warranty, contact us on our Sales Hotline on 1300 783 601, or send your claim to our postal address or fax line below and we will advise you as to how next to proceed. You will be required to supply a copy of your proof of purchase to make a claim under this warranty.

2) This warranty excludes transportation costs to and from White International or its appointed service agents and excludes defects due to non-compliance with installation instructions, neglect or misuse, inadequate protection against the elements, low voltage or use or operation for purposes other than those for which they were designed. For further information regarding the suitability of your intended application contact us on our Sales Hotline on 1300 783 601. If you make an invalid claim under this warranty, the original product will be sent back to you unrepai red.

3) This warranty refers only to products sold after the 1st January 2012, and is not transferable to another product type and only applies to the original owner, purchaser or end user, and is in addition to the consumer guarantees found within the Competition and Consumer Act 2010 (Cth) for goods purchased in Australia and the Consumer Guarantees Act 1993 (NZ) for goods purchased in New Zealand.

4) Our goods come with guarantees that cannot be excluded under the Australian Consumer Law. You are entitled to a replacement or refund for a major failure and for compensation for any other reasonably foreseeable loss or damage. You are also entitled to have the goods repaired or replaced if the goods fail to be of acceptable quality and the failure does not amount to a major failure. **2 YEAR WARRANTY**

5) To the fullest extent permitted by law, White International excludes its liability for all other conditions or warranties which would or might otherwise be implied at law. To the fullest extent permitted by law, White International's liability under this warranty and any other conditions, guarantees or warranties at law that cannot be excluded, including those in the Competition and Consumer Act 2010 (Cth), is expressly limited to: (a) in the case of products, the replacement of the product or the supply of equivalent product, the payment of the cost of replacing the product or of acquiring an equivalent product or the repair of the product or payment of the cost of having the product repaired, is at the discretion of White International or a 3rd party tribunal elected under the Competition and Consumer Act 2010 (Cth) for goods purchased in Australia and the Consumer Guarantees Act 1993 (NZ) for goods purchased in New Zealand; and

6) To the fullest extent permitted by law, this warranty supersedes all other warranties attached to the product or its packaging.

7) In the case of services, supplying the services again or the payment of the cost of having the services supplied again, is at the discretion of White International or a 3rd party tribunal elected under the Competition and Consumer Act 2010 (Cth) for goods purchased in Australia and the Consumer Guarantees Act 1993 (NZ) for goods purchased in New Zealand. 8) Our warranty commences from the date of purchase of the above mentioned pumps. Proof of purchase is required before consideration under warranty is given.

Record your date of purchase in the space below and retain this copy for your records.

Date of Purchase**Model Purchased**



www.whiteint.com.au

www.whiteint.co.nz

Please always refer to our website for further technical information & new product innovations

Disclaimer: Every effort has been made to publish the correct information in this manual. No responsibility will be taken for errors, omissions or changes in product specifications.

© 2024 Copyright White International Pty Ltd

TM ® - WARNING: Please be aware that various brands & products depicted within this document are subject to trademark, patent or design registrations. Infringement of any intellectual property contained within this document without express written authority by the appropriate intellectual property holder may result in further legal action to be taken. For any queries regarding use of the contained information please feel free to contact White International Pty Ltd.